

Supplement to Quickly Maintenance Manual (October 1956 Issue.)

(Repairs on **Quickly-S** and **L** which differ from the normal repair work on Quickly machines)

(The symbol „SW“ denotes across-flats, in mm)

WHEELS, BRAKES AND FORKS

Front Wheel - Removal and Fitting (S and L)

(F 01)

1. Disconnect the front brake cable nipple from the bottom brake lever. Undo the left-hand spindle nut (SW 15), slacken off the two pinch bolts (SW 12) on the swinging links and drive the spindle out to the right. Withdraw the wheel.
2. Assemble in the reverse order, seeing that the sealing ring seats properly in the left-hand side of the hub. On machines not equipped with a speedometer, the two spacer rings should be fitted to the left-hand spindle cone.

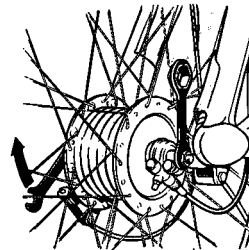

F 01 / 1

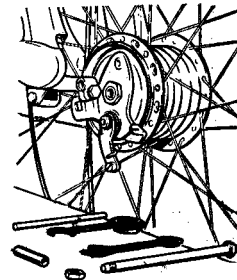

F 01 / 1a

Rear Wheel - Removal and Fitting (L)

(F 02)

1. Remove the safety loop, washer and pin from the rear brake lever. Undo the left-hand spindle nut (SW 15), drive the spindle out, and remove with the chain adjusters and distance piece. Lift the chain off the rear sprocket and withdraw the wheel downwards and to the left.
2. Assemble in the reverse order. Adjust the chain tension with the machine riderless so that it has about $\frac{3}{4}$ " (20 mm) free up-and-down movement; check to see that the wheels are properly aligned.

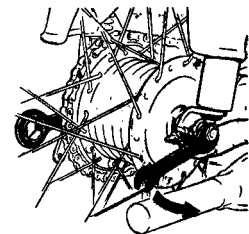

F 02 / 1

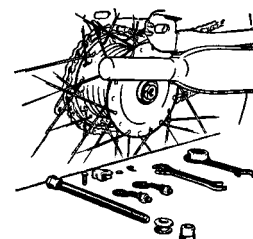

F 02 / 1a

Bearing Cups and Seals - Removal and Fitting (S and L)

(F 03)

1. Front wheel removal (see F 01). Front brake plate removal (s. F 04), or Rear wheel removal (see F 02). Rear brake plate removal (s. F 05).
2. Grip the left-hand cone in a vice by its two flats and completely unscrew the right-hand cone (SW 15). Force the cone, ball holder and seal right out two strong screwdrivers. Knock the left-hand cone out with a suitable drift, and use a strong screwdriver to remove the seal and ball holder. Knock the bearing cups out with a flat drift.
3. Assembly: Carefully tap the cups in with a suitable drift. Knock the right-hand cone in, complete with ball race and sealing ring, using grease to ease them in. Screw the left-hand cone on a few turns, together with its ball holder and seal (the lips on both seals should face inwards), and then knock the sealing ring into position. Set the bearings so that no play can be felt.

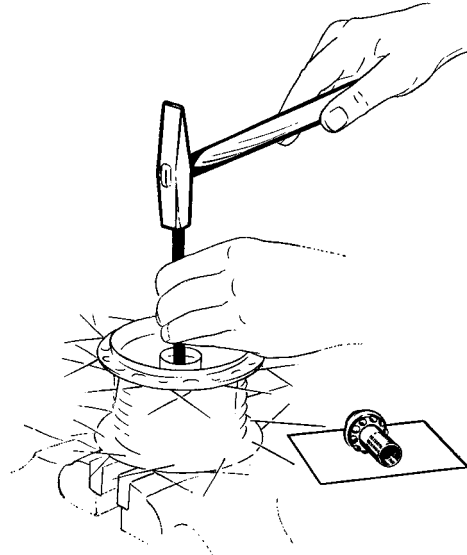

Fig. F 03/2b

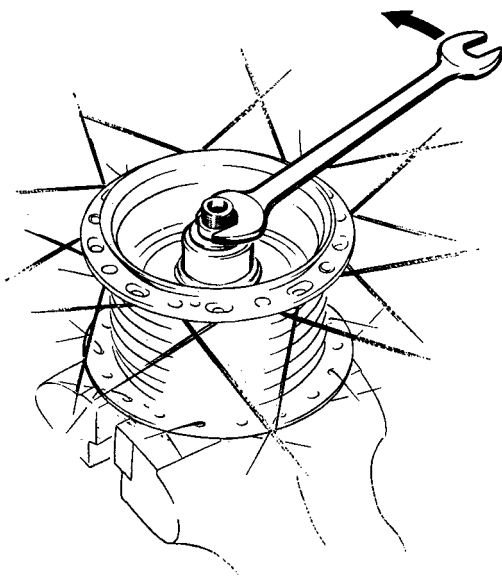

Fig. F 03/2

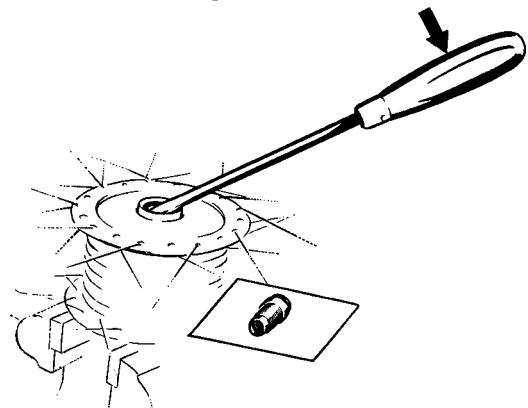

Fig. F 03/2c

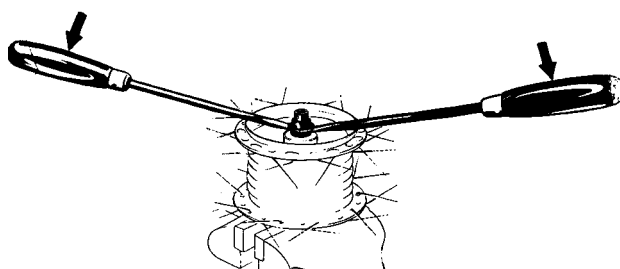

Fig. F 03/2a

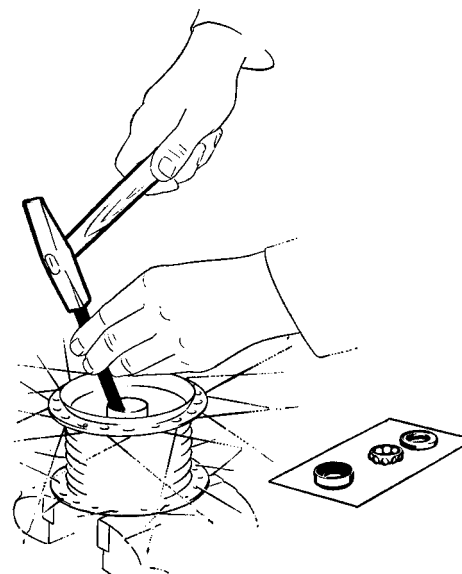

Fig. F 03/2d

Front Brake Plate - Removal and Fitting (S and L)

(F 04)

1. Front wheel removal (see F 01).
2. Undo the hexagon nut (SW 22) (applying opposite pressure to the brake lever) and take out the brake plate. Don't overlook the shim between the bearing cone and brake plate!
3. Assemble in the reverse order.

Rear Brake Plate - Removal and Fitting (S and L)

(F 05)

1. Rear wheel removal (see F 02).
2. The next stages are described in F 04. Tilt the brake plate and lift it out with its cover plate.
3. Assemble in the reverse order. First slip the cover plate over the sprocket.

Rear Sprocket - Removal and Fitting (S and L)

(F 06)

1. Rear wheel removal (see F 02).
2. Rear brake plate removal (see F 05).
3. Undo all the nuts (SW 9) with spring washers, and remove the sprocket and retaining screws.
4. Assemble in the reverse order and lock the nuts with a centre punch.

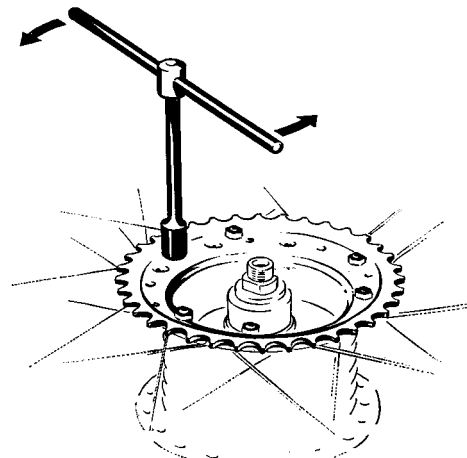

Fig. F 06/3

Rear Hub Cover - Removal and Fitting (S and L)

(F 07)

1. Rear wheel removal (see F 02).
Rear brake plate removal (see F 05).
2. Undo the nut (SW 11), remove the spring washer. Mark the position of the brake lever, force the lever off and withdraw the cover.
3. Assemble in the reverse order taking care to see that the brake lever is fitted in the correct position. Don't forget the shim between the bearing cone and brake plate.

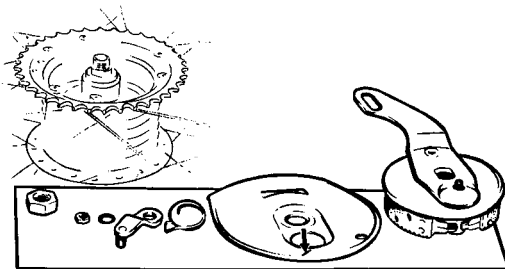

Fig. F 07/2

2. Undo the nut (SW 11), remove the spring washer. Mark the position of the brake lever, force the lever off and withdraw the cover.

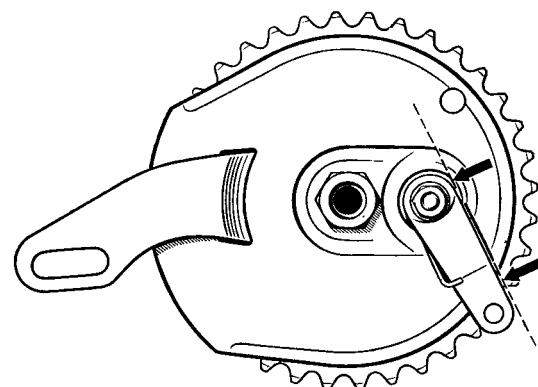

Fig. F 07/2a

Brake Linings on each Hub - Renewal (S and L)

(F 08)

1. Front wheel removal (see F 01).
Front brake plate removal (see F 04), or rear wheel removal (see F 02).
Rear brake plate removal (see F 05).
2. Unhook the return spring with a screwdriver and remove the brake shoes. Shear the rivet heads off with a chisel on the rear face of the brake shoes. Punch the remaining rivet portions out and take the linings off. When fitting the new linings, start riveting from the centre outwards.
3. Assembly: Fit both shoes into position and make sure when refitting the springs that they engage with the grooves in their anchor pins. Replace the brake plate into the hub, complete with shoes, turn the wheel and apply the brake. Remove the brake plate and smooth out any high spots on the linings with a file.

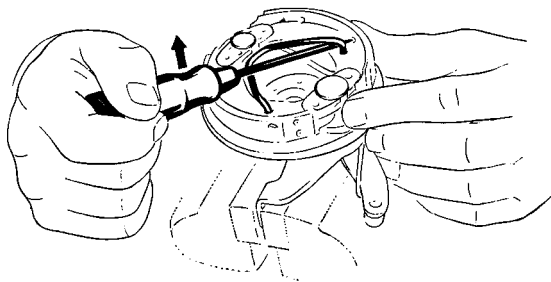

Fig. F 08/2

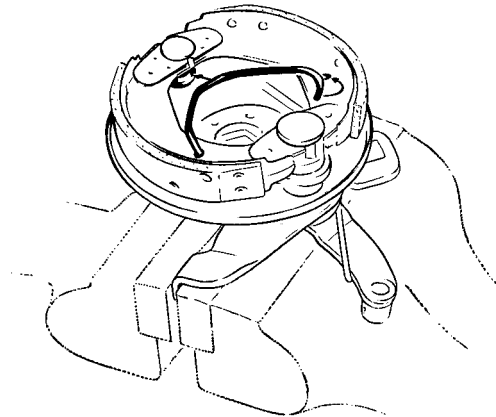

Fig. F 08/3

Front Forks - Removal and Fitting (L)

(F 20)

1. Front wheel removal (see F 01).
Front mudguard removal (see F 26).
Headlamp unit removal (see E 13).
Speedometer removal (see F 42).
Bell removal or rattle removal (see F 84 or E 08).
2. Undo the ring nut (SW 32) with a conventional twelve-sided socket spanner or with special spanner 16 91 00 917. Remove the two screws (SW 14) and serrated washers on the front forks, and place the complete handlebars on to the fuel tank (protect the tank with a soft rag). Remove the washer and undo the locknut (SW 36) (the

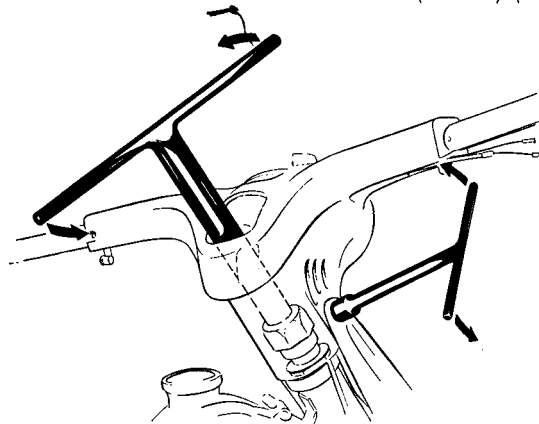

Fig. F 20/2

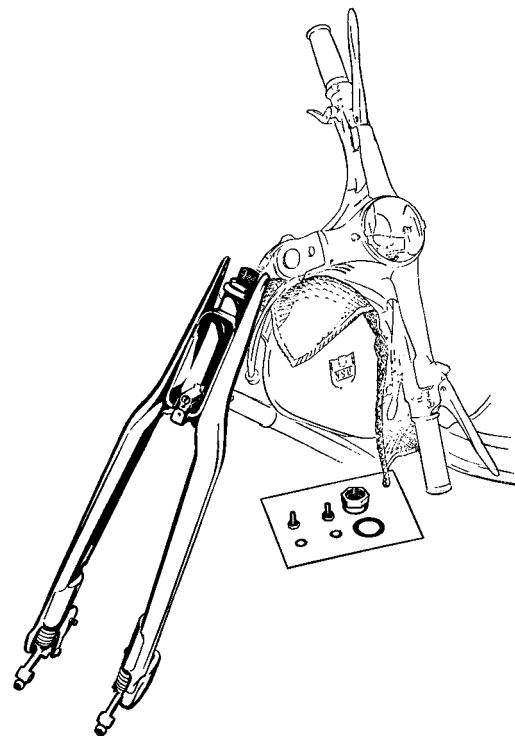

Fig. F 20/2a

balls will drop out of the bearings; the top and bottom races each contain 21 balls). Finally, remove the forks, cover plate, and the top bearing cone.

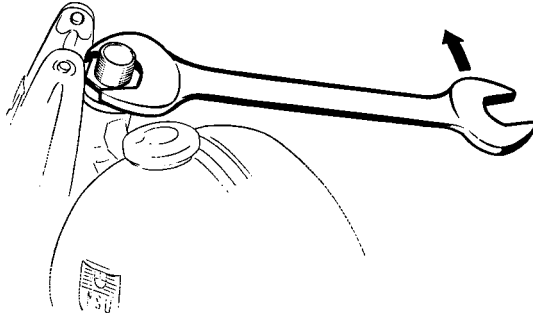

Fig. F 20/2b

3. Assemble in the reverse order. Adjust the fork by means of the locknut in such a way that it is free to swing over to either side under its own weight without the slightest sign of play. Lock by means of the nut (SW 32) and the ring nut. (The ring nut must be brought to bear up against the nut before it is screwed into the forks.)



correct

wrong

Fig. F 20/3

Bearing Cones and Cups, Balls - Removal and Fitting (S and L)

(F 21)

1. Front wheel removal (see F 01).
Front fork removal (see F 20).
2. Remove the cover plate, the top steering cone and balls, also the balls in the lower cone and cup. Drive the top and bottom steering head cups out with a suitable drift. Tap the steering cone off the fork tube with a flat drift, or lever it off with two screwdrivers.
3. Assembly: After driving the lower steering cone into the fork tube by means of a suitable piece of tubing and driving the two cups into the frame, insert 21 balls [$1\frac{3}{64}$ " dia (5 mm)] into the cups, using plenty of grease. For further assembly see F 20.



Fig. F 21/2

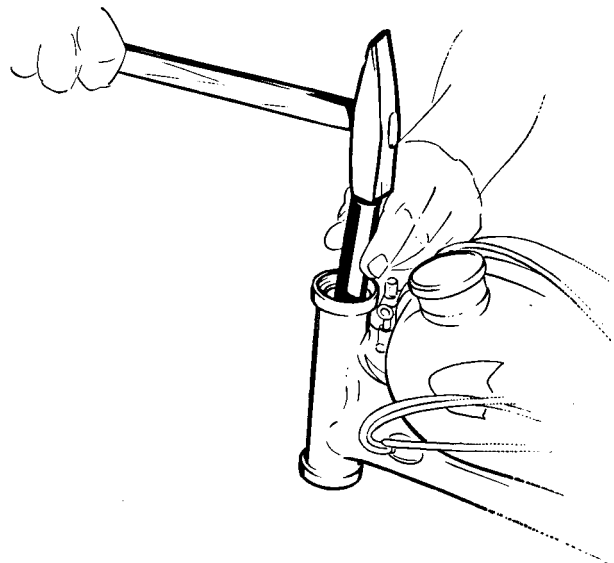

Fig. F 21/2b

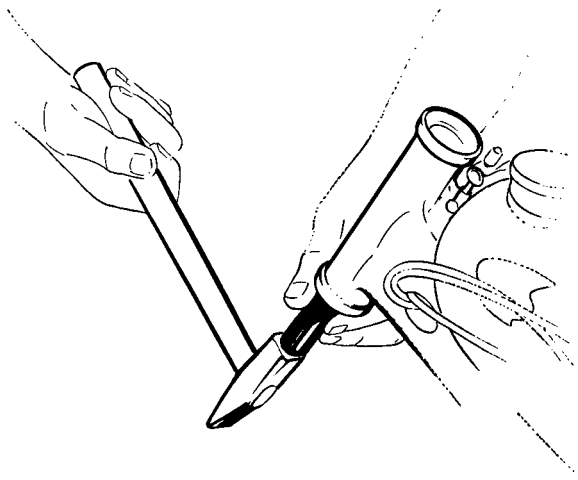

Fig. F 21/2a

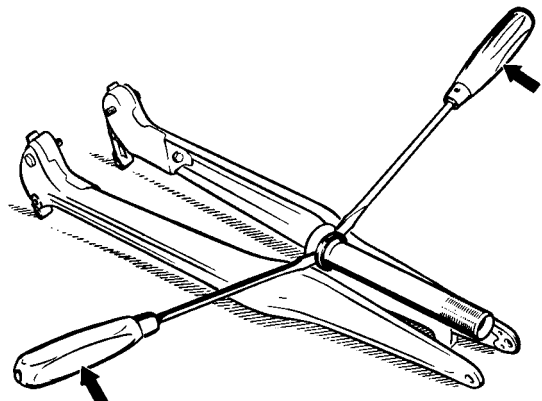

Fig. F 21/2c

Swinging Links, Right and Left-hand - Removal and Fitting (S and L)

(F 24)

1. Front wheel removal (see F 01).
2. Bend the front and rear tabs on the covering caps over to the left and right respectively. Remove the nut (SW 10) and its washer, (push the swinging link upwards and withdraw the hexagon screw), and remove the stop. Undo the locknuts (SW 14) on both bearing screws. Remove the screws and lift off the swinging links, complete with cover plates, distance bushes, fork springs and rubber plugs.
3. Assemble in the reverse order. Carefully bend over the tabs on the covering caps. Springs must always be replaced in pairs, observing the colour coding at their ends (yellow, blue, etc.).

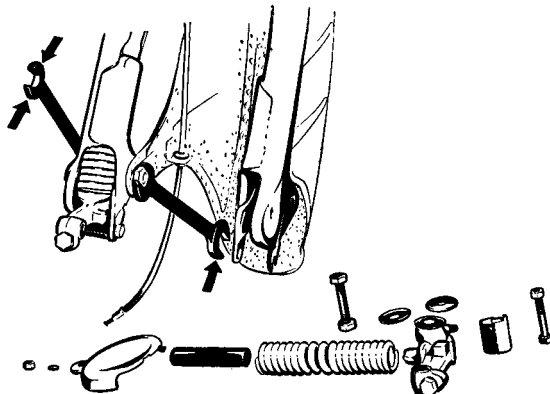

Fig. F 24

Bushes, Swinging Links - Renewal (S and L)

(F 25)

1. Front wheel removal (see F 01).
Swinging links removal (see F 24).
2. Drive the old bushes out with a suitable drift and press the new bushes in. Ream the bores out until the bushes are a sliding fit.

Front Mudguard - Removal and Fitting (L)

(F 26)

1. Front wheel removal (see F 01).
Remove the protecting caps and the locknuts (SW 14) (see F 24).
2. Undo the screw (SW 10) in the centre of the mudguard (inside) and remove with its spring washer; then remove the mudguard.
3. Assemble in the reverse order.

CONTROL LEVERS and CONTROL CABLES

Handlebars (including fittings) - Removal and Fitting (L)

(F 40)

1. Headlamp unit removal (see E 13). Bell removal or rattle removal (see F 84 and E 08 respectively). Speedometer removal (see F 42). Disconnect the clutch, front brake decompressor, carburetter and gear change control cables (see F 50, F 51, F 52, F 53, F 54).
2. Unscrew the nut (SW 32) with a conventional twelve-sided socket spanner or with special spanner 16 91 00 917, remove the 2 screws (SW 14) at the top fork ends their lock washer and lift the handlebars off.
3. Assemble in the reverse order.

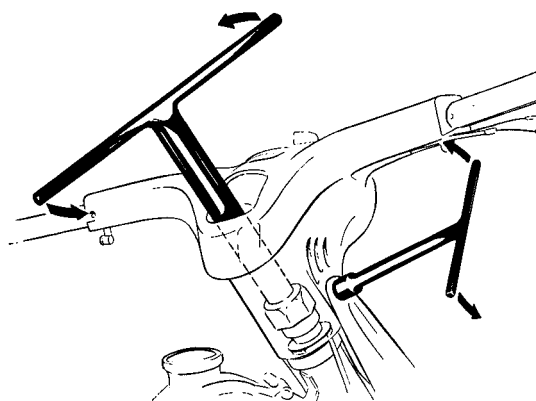

Fig. F 40/2

Handlebar Bend - Removal and Fitting

(F 41)

1. (see F 40).
Front brake control lever removal (F 44).
Twistgrip, throttle removal (F 45).
Twistgrip, gear change control removal (F 46).
2. Assemble in the reverse order.

Speedometer - Removal and Fitting

(F 42)

1. Headlamp unit removal (see E 13). Remove the toolbox lid. Disconnect the tension spring by removing the retaining clip from the underside of the headlamp shell. Undo the speedometer drive union nut and withdraw the speedometer upwards, complete with tension spring and flexible drive.
2. Assemble in the reverse order. A bent spoke can be used to reconnect the spring.

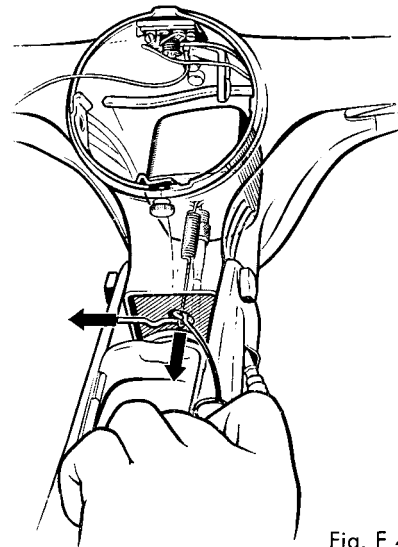

Fig. F 42

Flexible Drive, Speedometer - Removal and Fitting

(F 43)

(see F 42).

Control Lever, Front Brake - Removal and Fitting

(F 44)

1. Disconnect the front brake control cable (see F 51). Undo the lever retaining screw (SW 9) on the underside of the handlebar and remove, with its washer, plate spring and the lever itself.
2. Assemble in the reverse order. The plate spring must be fitted with its convex side facing the head of the screw.

Control Lever, Clutch - Removal and Fitting

(F 44 a)

1. Disconnect the clutch control cable (see F 50). Remove the nut (SW 9) and its serrated washer, unscrew the retaining screw and take the lever off.
2. Assemble in the reverse order.

Twistgrip, Throttle - Removal and Fitting (L)

(F 45)

1. Close the twistgrip. Undo the locknut (SW 9) on the underside of the twistgrip housing, unscrew the grub screw a few turns, turn the twistgrip and thrust washer to the right and withdraw.
2. Assemble in the reverse order. Grease the slider and screw the grub screw in until the twistgrip no longer closes by itself; then lock with the locknut (SW 9).

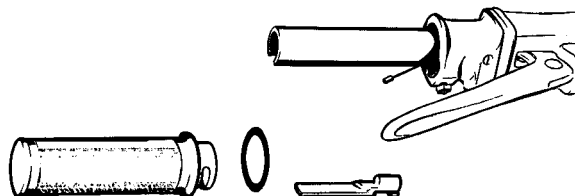

Fig. F 45

Twistgrip, Gear Change Control - Removal and Fitting (L)

(F 46)

1. Headlamp unit — removal (see E 13).
Speedometer — removal (see F 42).
Control cable, clutch, removal (see F 50).
Control cable, gear change removal (see F 54).
2. Remove the slotted screw from the decompressor control lever with its serrated, corrugated and plain washers; unscrew the slotted screw and grub screw after undoing a locknut (SW 9). Pull the twistgrip slightly outwards, turning it upwards at the same time, and disconnect the gear change control cable nipple in the headlamp recess. Remove the twistgrip, complete with its rod, housing and moulding strip.

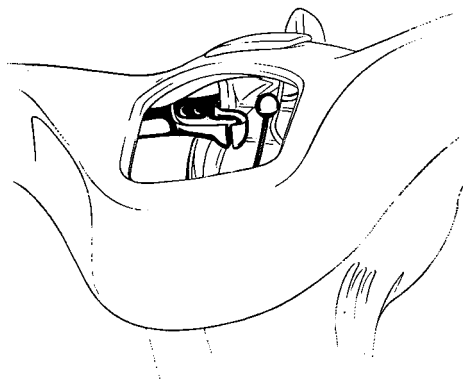

Fig. F 46/2a

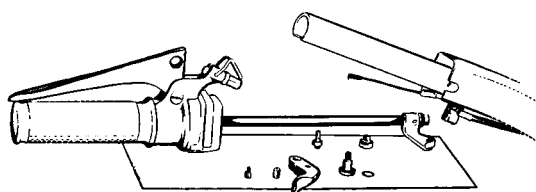

Fig. F 46/2

3. Assemble in the reverse order. Grease the twistgrip housing. Don't overlook the gear change rod bush! Adjust the gear change control system by means of the cable adjuster if required.

Rubber Grip, Twistgrip - Removal and Fitting (S and L)

(F 47)

1. Slightly lift the end of the grip with a small screwdriver and pour in a few drops of petrol. Withdraw the grip with a twisting motion.
2. Assembly: — Wet the grips with petrol and push them on with a quick twisting motion.

Slider - Removal and Fitting (L)

(F 48)

(see F 53), excluding „Control Cable — Removal and Fitting“.

Control Cable, Clutch - Removal and Fitting (L)

(F 50)

1. Headlamp Unit — Removal (E 13).
2. Remove the chainguard on the left-hand side of the engine, after first undoing its slotted screw and another screw on the right-hand side (above the lifting handle). Disconnect the nipple from the clutch lever (engine end). Remove the nipple holder from the clutch lever (handlebar lever), disconnecting the cable in the process.
3. Assembly: — Use the old Bowden cable to pull the new one through, tying the two together with binding wire.

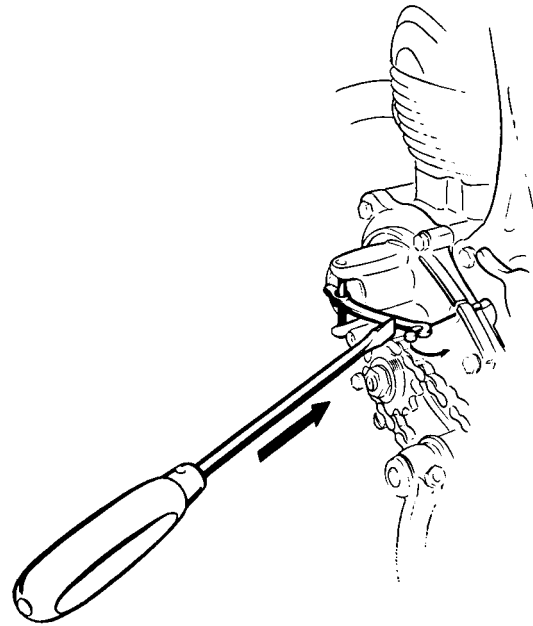

Fig. F 50

Control Cable, Front Brake - Removal and Fitting (L)

(F 51)

1. Disconnect the nipple from the lower brake lever. Remove the nipple holder from the handlebar-mounted lever. Set the adjuster and star nut with their slots in line, then disconnect the control cable and pull out upwards.
2. Assemble in the reverse order.

Control Cable, Decompressor - Removal and Fitting (L)

(F 52)

1. Headlamp Unit — Removal (see E 13).
2. Push the decompression lever on the cylinder head inwards with a screwdriver, and disconnect the cable. Undo the screw on the nipple, pull out the inner cable, and withdraw the Bowden cable downwards.
3. Assemble in the reverse order. Set the cable by means of the adjuster to leave about $\frac{3}{64}$ " (1 mm) free movement.

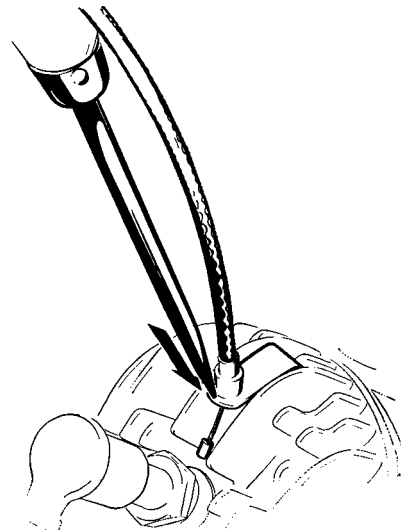

Fig. F 52

Control Cable, Throttle - Removal and Fitting (L)

(F 53)

1. Twistgrip, Throttle — Removal (F 45).
Remove the carburetter screw cap and disengage the control cable nipple from the throttle slide. Slightly loosen the fuel tank mountings and slip the cable out underneath the rubber tank pads.
2. Assemble in the reverse order.

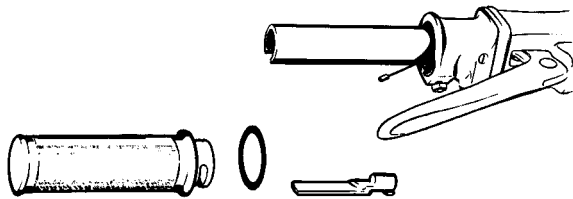

Fig. F 53

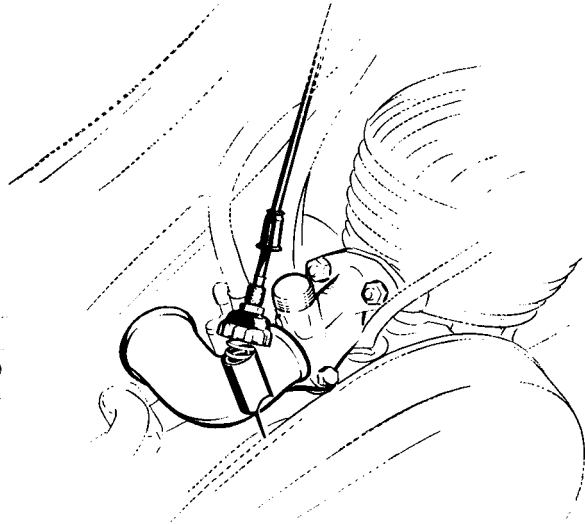

Fig. F 53a

Control Cable, Gear Change - Removal and Fitting (L)

(F 54)

1. Remove the flywheel magneto cover on the right-hand side after undoing the countersunk screw. Select 2nd gear, push the gear selector lever inwards and disconnect the nipple. Next, carry out the operations listed in F 46, up to „disconnect the gear change control cable nipple in the headlamp recess“. Tie about 5 feet (1 m 50) of binding wire to the bottom nipple and pull the cable out upwards.
2. Assembly: — Use the same length of wire to pull the new cable through. Fit the slotted cable bush into the right-hand crankcase half; connect the top nipple first. Try all the gears in turn and adjust the control system by means of the adjuster.

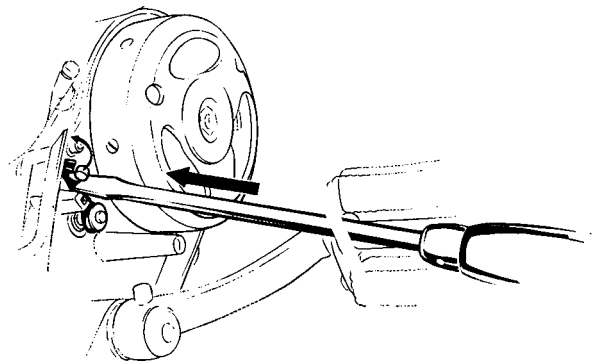

Fig. F 54

Control Cable, Rear Brake - Removal and Fitting (L)

(F 56)

1. Remove the front and rear locking springs. Remove the washers and pins. Undo the locknut (SW 10) and unscrew the adjuster (SW 9). Remove the cable clip and pull out the cable and rubber sleeves.
2. Assemble in the reverse order. Make sure the cable is correctly adjusted.

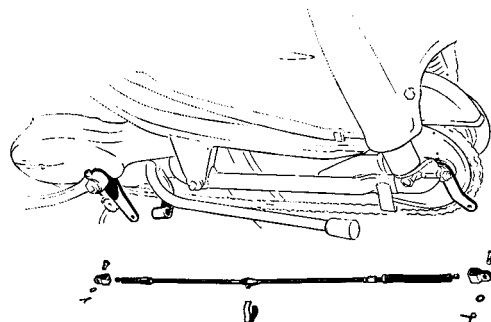

Fig. F 56

FRAME

Frame - Removal and Fitting (L)

(F 60)

1. Front Forks — Removal (see F 20).
Control cables removal (see F 50, F 51, F 52, F 54).
Fuel tank — removal (see F 80).
Frame, rear frame member removal (see F 62).
Rear wheel removal (see F 02).
Removing the power unit (see M 01).
Rear suspension swinging arm removal (see F 63).
2. Assemble in the reverse order. Fit all the Bowden cables and the electric wiring harness to the frame before fitting the engine.

Frame, Rear Frame Member - Removal and Fitting (L)

(F 62)

1. Rear wheel removal (see F 02).
Pivoted saddle removal (see F 72).
Rear light removal (see E 09).
2. Pull the rear light lead out through the eyes.
Remove the blanking plug on the upper left-hand side and undo the slotted screw. Remove the two front slotted screws and their washers, spring washers and nuts (SW 10). Unscrew the two screws (SW 10) at the rear and remove, with their washer, spring washers and nuts. Lift the complete rear frame member off, with its moulding strip, clips, spacers and seals.

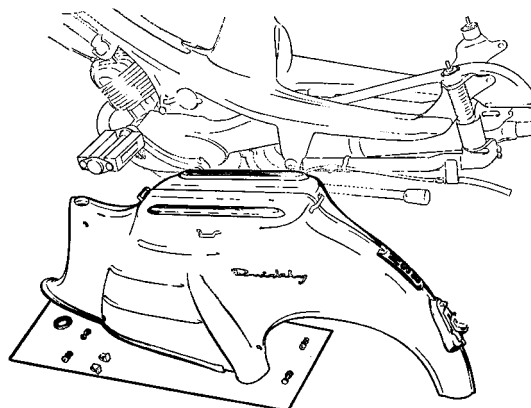

Fig. F 62/2

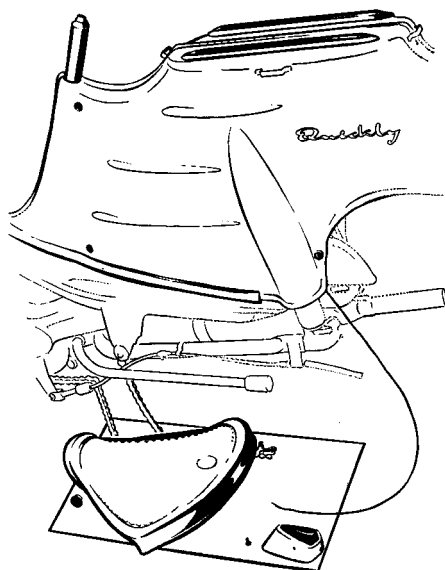

Fig. F 62

3. Assemble in the reverse order. Insert the seal above the retaining clip into the rear frame member before placing the latter on to the frame. Finally, tighten the top slotted screw.

Rear Suspension Swinging Arm - Removal and Fitting (L)

(F 63)

1. Rear wheel — removal (F 02).
Frame, rear frame member removal (F 62).
2. Unscrew the locknuts (SW 9), holding the threaded disc in place (SW 18). Twist the retaining rods out with a screwdriver, then push the swinging arm down and remove the springs, spring caps, and shock absorbers. Push the lock washers out and remove the distance bushes, spring washers sliders and retaining rods. Undo the Bowden cable adjuster (SW 9) and locknut (SW 10). Unscrew the self-locking nuts (SW 14) on the inside of the swinging arm and drive the bearing bolts out from the inside with a brass drift. Remove the swinging arm with its inner and outer shims.

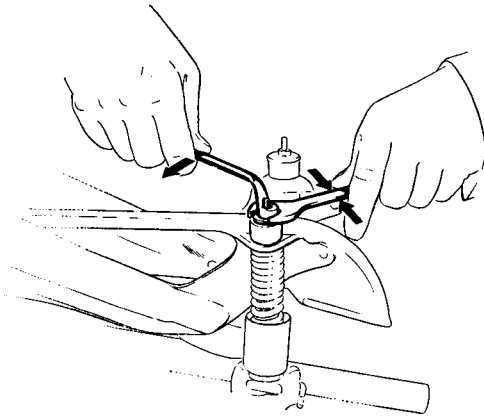

Fig. F 63/2

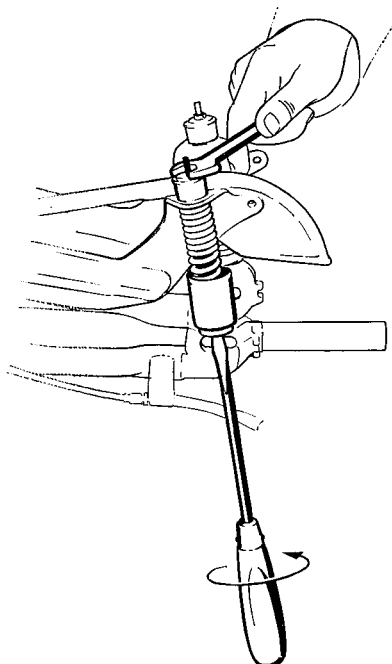

Fig. F 63/2a

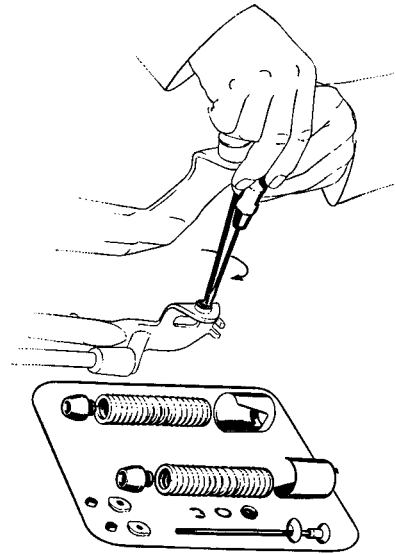

Fig. F 63/2b

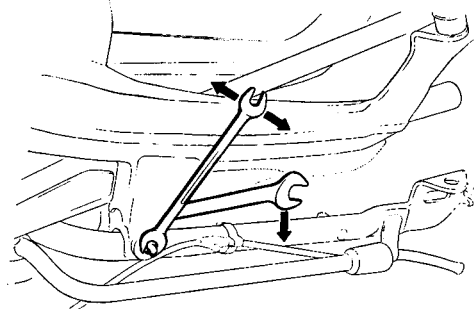

Fig. F 63/2c

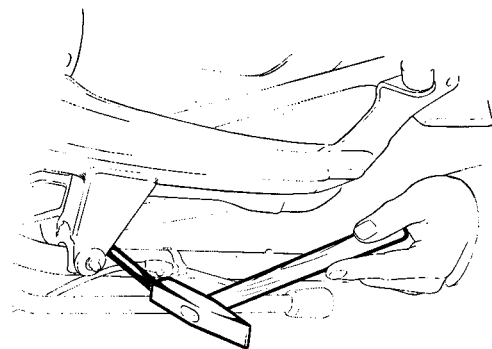

Fig. F 63/2d

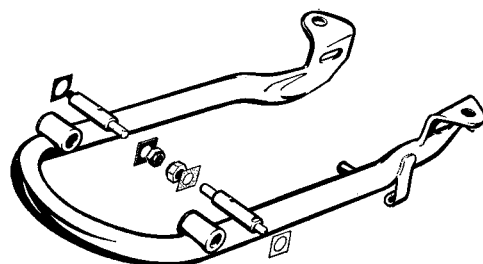

Fig. F 63/2e

3. Assembly: — Stick the outer and inner shims to the bearing brackets with grease, grease the bearing bushes, place the swinging arm into position, insert the bearing bolt, seeing that the shims are correctly positioned, and drive the bearing bolt in with drift 11 91 00 921 or with a suitable piece of tubing. Then draw up the self-locking nuts (SW 14) dead tight. Coat the slider with graphite and then insert it, together with the retaining rod, from the bottom; slip the distance bush and spring washer over the end of the swinging arm and lock. Fit the spring caps with the end holes facing forward. Insert the springs, push the shock absorbers into position, lift the swinging arm and screw the threaded discs in until there is a clearance of $4 \frac{11}{64}$ " (106 mm) between the swinging arm and the frame on both sides. Lock the threaded discs with the locknuts (SW 9). Carry out the remaining assembly in the reverse order to dismantling.

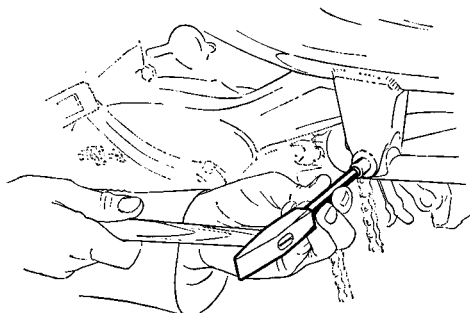

Fig. F 63/3

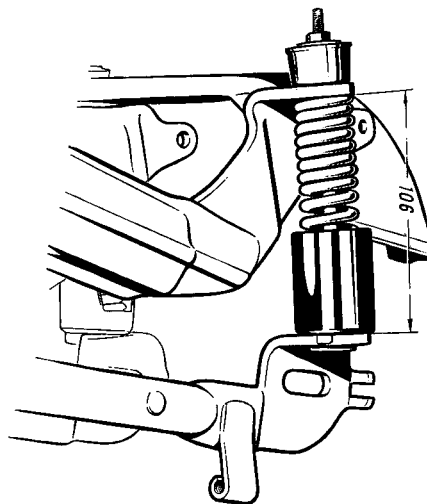

Fig. F 63/3a

Rear Suspension - Removal and Fitting (L)

(F 65)

1. Rear wheel removal (F 02).
Frame, rear frame member — removal (F 62).
Remaining operations, see F 63, para. 2, not including swinging arm removal.
2. Assemble in the reverse order. Fork springs should only be renewed in pairs, noting the colour coding (yellow, blue, etc.).

Exhaust System - Removal and Fitting (L)

(F 70)

1. Remove the screw (SW 10) and its spring washer from the clip on the frame. Undo the exhaust pipe nut on the cylinder and then remove the exhaust system with its gasket.
2. Assemble in the reverse order. Lubricate the exhaust pipe nut with graphite when refitting.

Pivoted Saddle - Removal and Fitting (L)

(F 72)

1. Undo the nut (SW 15) on the saddle clamp and remove the saddle.
2. Assemble in the reverse order.

Prop Stand - Removal and Fitting (L)

(F 73)

1. Place the machine on to its centre stand. Remove the chain cover (left-hand side of engine) after undoing the two countersunk screws (see also F 50). Disconnect the rear brake cable (see F 55). Unscrew the screw (SW 10) and remove, with its serrated washer and nut (SW 14), remove the prop stand.
2. Assemble in the reverse order.

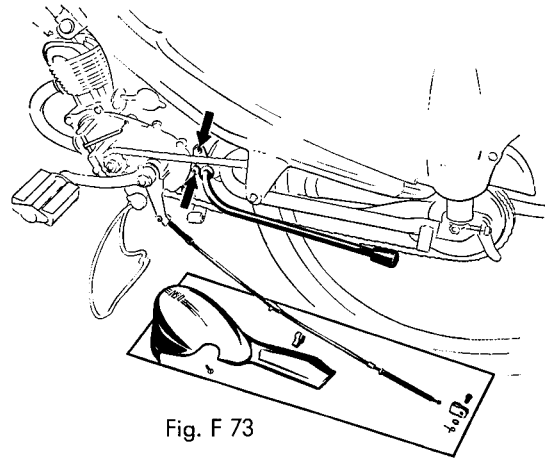

Fig. F 73

Centre Stand - Removal and Fitting (S and L)

(F 74)

1. Place the machine on to its prop stand. Remove the splitpin from the right-hand side. Knock the bearing tube out and remove the sprung stand and its washers.
2. Assemble in the reverse order.

Parcel-carrier Strips - Removal and Fitting (L)

(F 75)

1. Rear wheel — removal (see F 02). Remove the 4 nuts (SW 7) and their spring washers from the inside of the rear frame member and remove the strips.
2. Assemble in the reverse order.

Fuel Tank - Removal and Fitting (L)

(F 80)

1. Pull the fuel line off the tap. Unscrew the nut (SW 8) and remove, with its lock washer. Lift the strap up and remove the tank.
2. Assemble in the reverse order.

Fuel Tap - Removal and Fitting

(F 82)

1. Pull the fuel line off the tap. Tilt the machine over to the left and unscrew the tap and its union nut (SW 17).
2. Assemble in the reverse order.

Bell - Removal and Fitting

(F 84)

1. Headlamp unit removal (see E 13). Loosen the screwed nipple on the handlebars with a suitable screwdriver. Undo the screw (SW 10) and remove, with its spring washers. Remove the bell and its pull wire.
2. Assemble in the reverse order. In order to avoid bending the pull wire, hold the screwed nipple steady with a screwdriver when tightening the screw.

Pedals - Removal and Fitting

(F 85)

1. The left and right-hand pedals are marked „L“ (left-hand thread) and „R“ (right-hand thread) respectively. Unscrew the pedals with an open-ended spanner (SW 15).
2. Assemble in the reverse order.

ELECTRICAL SYSTEM

Cable - Rear Light - Removal and Fitting (S and L)

(E 02)

1. Headlamp unit removal (E 13). Disconnect both leads from their terminals and withdraw downwards, with their protecting sleeve. Remove the countersunk screw from the rear light, remove the protecting cap and disconnect the lead. Withdraw the cables to the front through the eyes in the rear frame member. Tie about 5 feet (1,5 m) of binding wire to the end of the cable and pull it out to the front.
2. Assembly: — Pull a new cable through, using binding wire as before. Connect the rear light lead to the red terminal in the headlamp (see Wiring Diagram).

Wiring Diagram
(Quickly N and S)

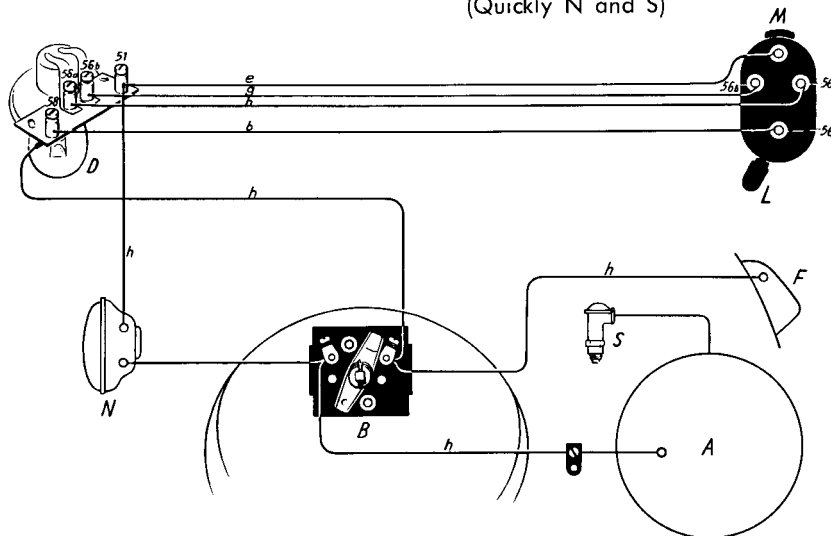

- A Flywheel magneto and lighting generator
- B Switch plate
- D Double-filament bulb
- F Rear lamp
- L Dipper switch
- N Horn
- S Sparking plug
- b red
- e white
- g green
- h grey

Wiring Diagram
(Quickly L)

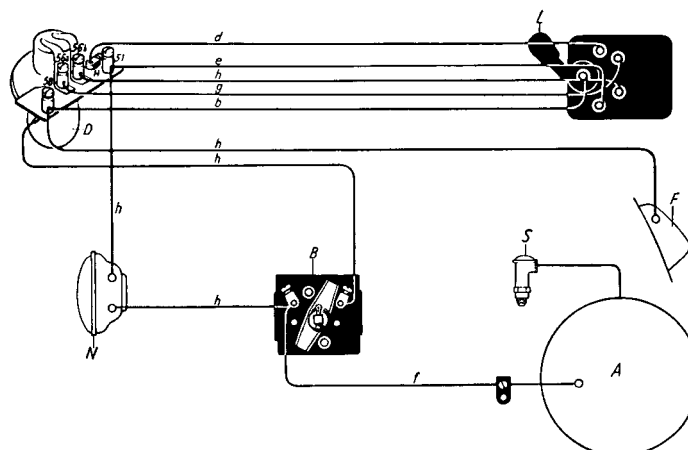

- A Flywheel dynamo
- B Starting, ignition and lightning switch
- D Headlamp bulb (double-filament)
- F Tail light bulb
- L Dipper switch
- N Horn
- S Sparking plug
- b red
- d yellow
- e white
- f blue
- g green
- h grey

Cables, Main Lighting - Removal and Fitting (S and L)

(E 04)

1. Headlamp unit removal (E 13).
Disconnect both leads from their terminals and withdraw downwards, with their protecting sleeve. Remove the flywheel magneto cover on the right-hand side, after undoing the slotted screw, and disconnect the lead. Withdraw the cable as described in E 02.
2. Assembly: — See E 02 (Refer to the Wiring Diagram).

Cables, Dipped Beam - Removal and Fitting (L Export)

(E 05)

1. Dipswitch removal (see E 10).
Headlamp unit removal (see E 13).
Disconnect all the dipper cables and withdraw.
2. Assemble in the reverse order, connecting up as shown on the Wiring Diagram.

Rattle - Removal and Fitting (L Export)

(E 08)

1. Headlamp unit removal (see E 13).
Undo the screw (SW 10) and remove, with its spring washers. Disconnect the lead and remove the rattle.
2. Assemble in the reverse order.

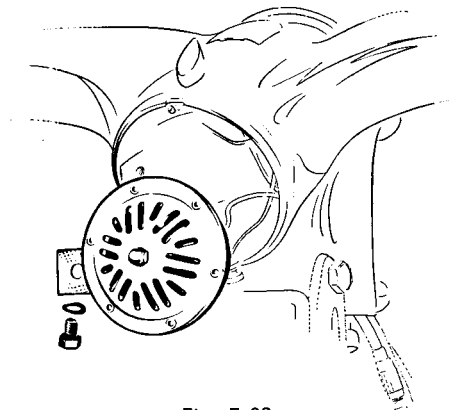

Fig. E 08

Rear Light - Removal and Fitting (L)

(E 09)

1. Remove the countersunk screw and the protecting cap. Disconnect the lead. Remove the nuts (SW 9) on the inside of the rear frame member, together with their lock washers, and remove the bulb-holder unit and rubber backing plate.
2. Assemble in the reverse order.

Dipswitch - Removal and Fitting (L Export)

(E 10)

1. Remove the countersunk screw from the dip-switch, push the distance ring out with a small screwdriver and take the switch, terminal plate and horn button out of the housing. Disconnect the leads, taking care to mark them.
2. Assemble in the reverse order. (Refer to the wiring diagram).

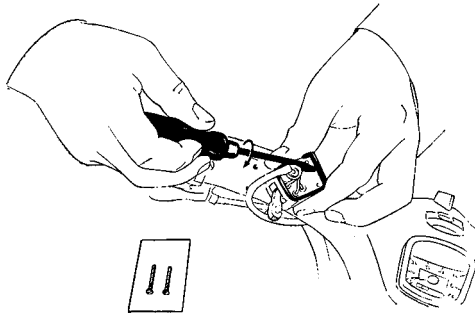

Fig. E 10/1

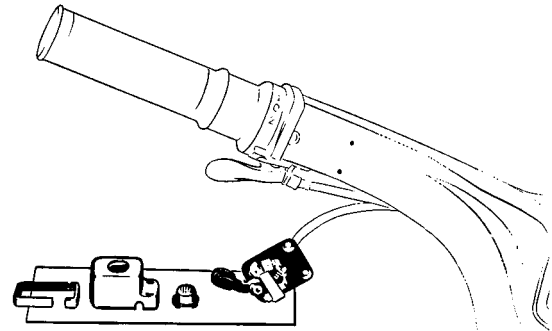

Fig. E 10/1 a

Headlamp Glass and Reflector - Removal and Fitting (L)

(E 12)

1. Headlamp unit — removal (see E 13).
2. Push the terminal over to one side and remove the bulb. Undo the adjusting screw with a screwdriver and remove the compression spring, washer, earth terminal and square nut. Remove both retaining springs and lift the reflector out. Remove the three retaining springs from the headlamp glass and take the sealing ring off.
3. Assemble in the reverse order. Fit the headlamp glass with its projecting part facing downwards and engaging in the slot provided in the headlamp rim. When the headlamp unit has been fitted, set the reflector by means of the adjusting screw.

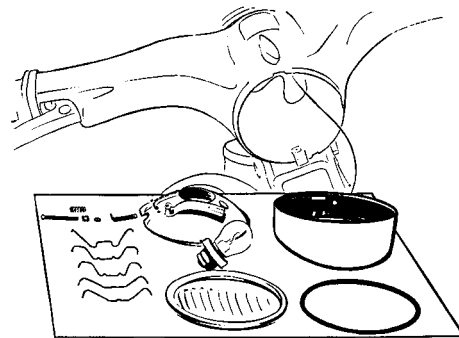
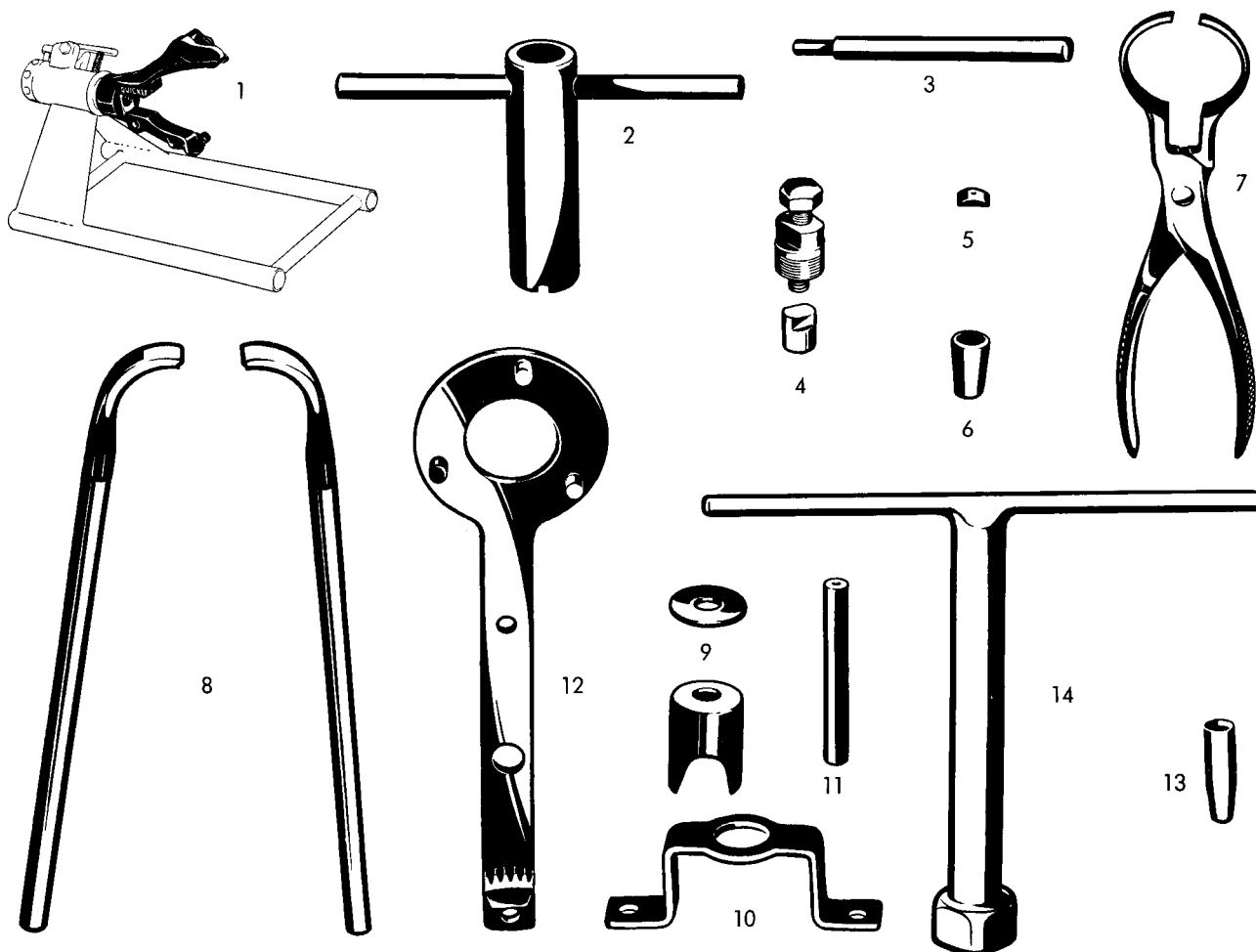

Fig. E 12

Headlamp Unit - Removal and Fitting (L)

(E 13)

1. Undo the knurled screw on the underside of the headlamp unit, remove the unit and disconnect the leads.
2. Assemble in the reverse order.



One Set of Special Tools for the QUICKLY comprises: -

Fig. No.		
1	1 Clamping fixture for engine	16 91 00 901
	(If an NSU assembly stand is not available, it is possible to make do by holding the clamping fixture in a vice.)	
2	1 Box spanner for pedal crank spindle	16 91 00 902
3	1 Punch for gudgeon pin	16 91 00 903
4	1 Extractor with cap for flywheel with pole shoes	16 91 02 904
5	1 Filler piece for pedal crank spindle	16 91 00 905
6	1 Tapered sleeve for fitting left-hand end of pedal crank spindle	16 91 00 906
7	1 Piston ring pliers	16 91 00 907
8	2 Levers for removing clutch cup	16 91 00 908
9	1 Assembly sleeve for inner clutch casing	16 91 00 909
10	1 Assembly bracket for clutch spring	16 91 00 910
11	1 Setting pin for connecting rod	16 91 00 911
12	1 Holder for rotor and intermediate gear	16 91 00 913
13	1 Tapered sleeve for use when assembling crankcase	018 110 282

These tools are supplied in sets, the number for which is **16 91 01 914**.

To remove the chain sprocket, a normal commercial extractor or Fox extractor No. 048 422 007 will also be required.

Special tool required additionally for model »L«

Fig. No. 14 1 Box spanner for disassembling of handlebar 16 91 00 917.

The right to make technical modifications is reserved.

The Flat Rate Repair Times have been calculated for vehicles with the standard equipment. The time required for any cleaning that may be necessary is **not** included.

Wheels, Brakes, and Forks

- F 01 Remove and fit front wheel (S and L)
- F 02 Remove and fit rear wheel (L)
- F 03 Remove and fit ball-bearing cup or seal in hub (S and L)
- F 04 Remove and fit front-brake back plate (S and L)
- F 05 Remove and fit rear-brake back plate (S and L)
- F 06 Remove and fit rear sprocket (S and L)
- F 07 Remove and fit rear hub cover (S and L)
- F 08 Renew brake linings (each brake) (S and L)
- F 20 Remove and fit forks (L)
- F 21 Remove and fit steering-head cones and cups and ball bearings (S and L)
- F 24 Remove and fit pivoted links (left-hand and right-hand) (S and L)
- F 25 Replace bushes in pivoted links
- F 26 Remove and fit front mudguard

Control and Bowden Cables

- F 40 Remove and fit handlebars (with fittings) (L)
- F 41 Remove and fit handlebar bend (L)
- F 42 Remove and fit speedometer (L)
- F 43 Remove and fit flexible drive, speedometer (L)
- F 44 Remove and fit control lever, front brake (L)
- F 44a Remove and fit control lever, clutch (L)
- F 45 Remove and fit throttle twistgrip (L)
- F 46 Remove and fit gear change twist grip (L)
- F 47 Remove and fit twistgrip sleeve (S and L)
- F 48 Remove and fit slider (L)
- F 50 Remove and fit clutch cable (L)
- F 51 Remove and fit brake cable (L)
- F 52 Remove and fit decompression cable (L)
- F 53 Remove and fit throttle cable (L)
- F 54 Remove and fit gearchange cable (L)
- F 56 Remove and fit control cable, rear brake (L)

Time for task (hours)	Additional work required	Total time (hours)
Temps unitaire (heures)	Travaux supplémentaires indispensables	Temps total (heures)
Tijd (uren)	Benodigde extra werkzaamheden	Totaaltijd (uren)
Einzelzeit (Std.)	erforderliche Zusatzarbeiten	Gesamtzeit (Std.)
¼	—	¼
¼	—	¼
½	F 01, F 04 <u>or</u> F 02, F 05	1
¼	F 01	½
¼	F 02	½
¼	F 02, F 05	¾
¼	F 02, F 05	¾
¾	F 01, F 04 <u>or</u> F 02, F 05	1½
½	F 26, F 42, F 84 or E 08, E 13	1¾
¼	F 20	2
¾	F 01	1
¾	F 01, F 24	1¾
¼	F 01	½
¼	F 42, F 84, or E 08, E 13, F 50 F 51, F 52, F 53 F 54	1½
—	F 40, F 44, F 44a F 45, F 46	2½
¼	E 13	½
—	F 42	½
¼	—	¼
¼	—	¼
¼	—	¼
¼	F 42, s. F 50 and F 54	1
¼	—	¼
¼	s. F 53	¼
½	E 13	¾
¼	—	¼
¼	E 13	½
¼	F 45	½
½	s. F 46	1
¼	—	¼

Frame

F 60	Remove and fit frame (L)
F 62	Remove and fit rear frame member (L)
F 63	Remove and fit rear suspension swinging arm (L)
F 65	Remove and fit rear suspension (L)
F 70	Remove and fit exhaust system (L)
F 72	Remove and fit pivoted saddle (L)
F 73	Remove and fit prop stand (L)
F 74	Remove and fit centre stand (S and L)
F 75	Remove and fit parcel-carrier strips (L)
F 80	Remove and fit fuel tank (L)
F 82	Remove and fit fuel tap
F 84	Remove and fit bell (L)
F 85	Remove and fit pedals

Electrical Installation

E 02	Remove and fit rear lamp lead (S and L)
E 04	Remove and fit lighting leads (S and L)
E 05	Remove and fit cables, dipped beam (L Export)
E 08	Remove and fit rattle (L Export)
E 09	Remove and fit rear lamp (L)
E 10	Remove and fit dipswitch (L Export)
E 12	Remove and fit headlamp glass and reflector (L)
E 13	Remove and fit headlamp unit (L)

Care and Maintenance

W 01	Grease vehicle (L)
------	------------------------------

Time for task (hours)	Additional work required	Total time (hours)
Temps unitaire (heures)	Travaux supplémentaires indispensables	Temps total (heures)
Tijd (uren)	Benodigde extra werkzaamheden	Totaaltijd (uren)
Einzelzeit (Std.)	erforderliche Zusatzarbeiten	Gesamtzeit (Std.)
¼	F 20, F 63, F 73 F 80, M 01	5¾
½	F 02, F 72, E 09	1¼
¾	F 62	2
¼	F 62, F 63	1¾
¼	—	¼
¼	—	¼
¼	—	¼
¼	—	¼
¼	F 02	½
¼	—	¼
¼	—	¼
¼	E 13	½
¼	—	¼
¾	E 13	1
¾	E 13	1
—	E 10, E 13	½
¼	E 13	½
¼	—	¼
¼	—	¼
¼	E 13	½
¼	—	¼
½	—	½